

Software is not the only Fruit

Modelling Mechatronic Systems

Colin Hood Systems Engineering Ltd
4 Summerhouse Road
Northampton NN3 6BJ
Great Britain

info@colinhood-se.com

- To discuss modelling, its history, and its applicability to many domains of systems engineering

Modelling can help to:

- i. understand what is required
- ii. to explain what has been understood to promote a common understanding
- iii. to plan the implementation of a solution by creating a design
- iv. enable checking a specification for consistency and other quality criteria
- v. to support simulation and prediction, or
- vi. to generate implementation directly from a model, by abstracting reality to enable concentration on the matter interest

Modelling in the 1970's



Source:
<https://www.indiamart.com/svpservices/cad-draughtsman.html>

- From orthogonal views the whole part is specified

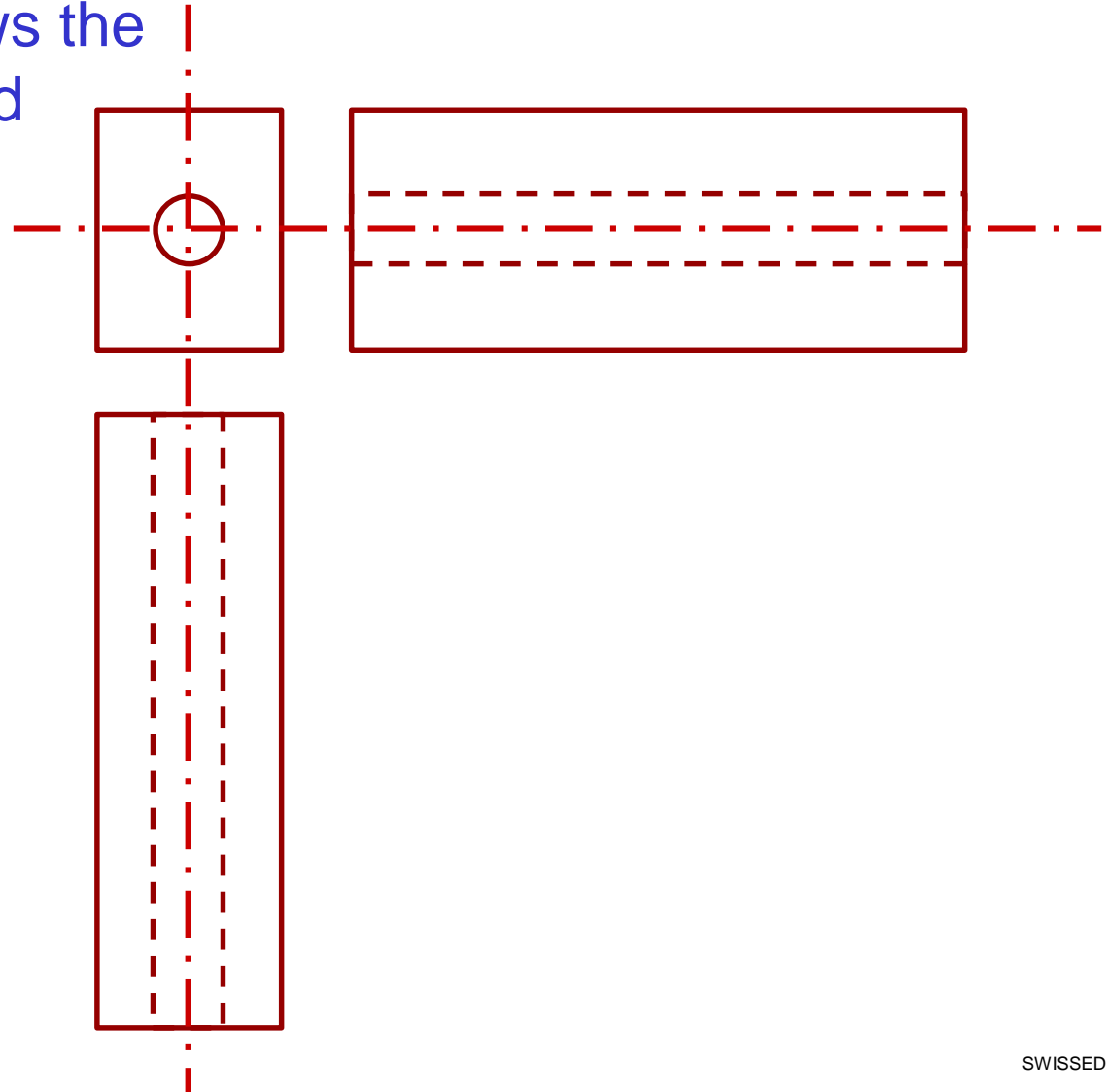

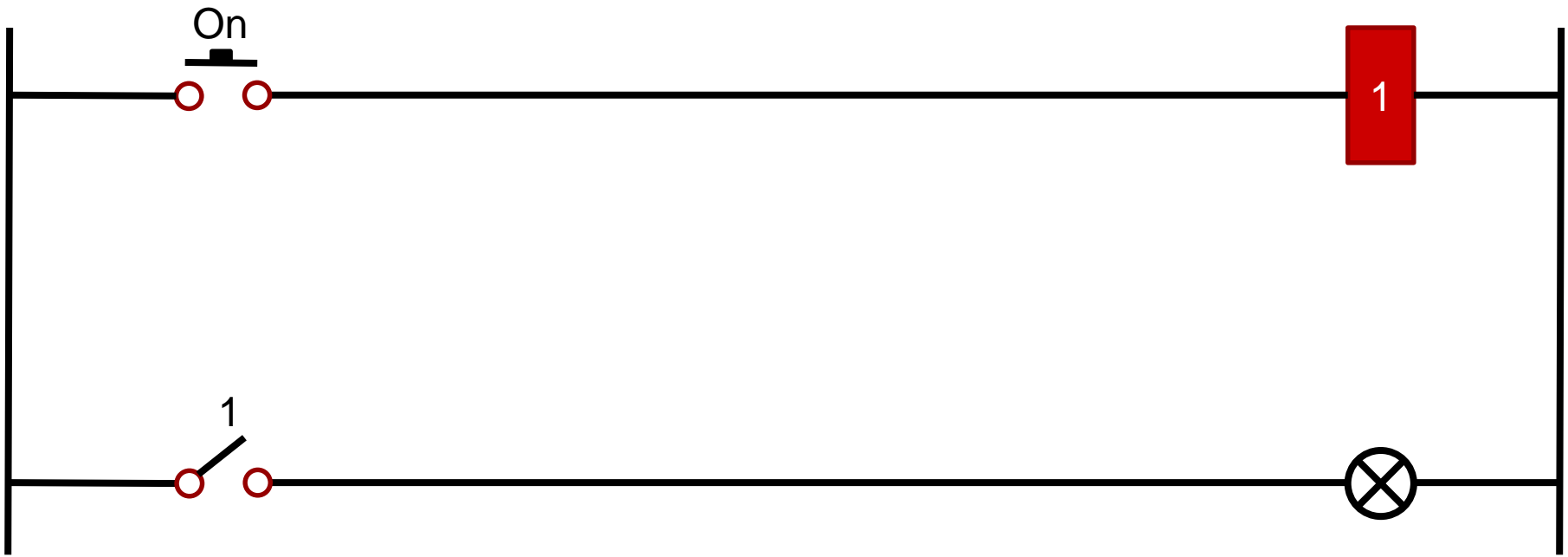

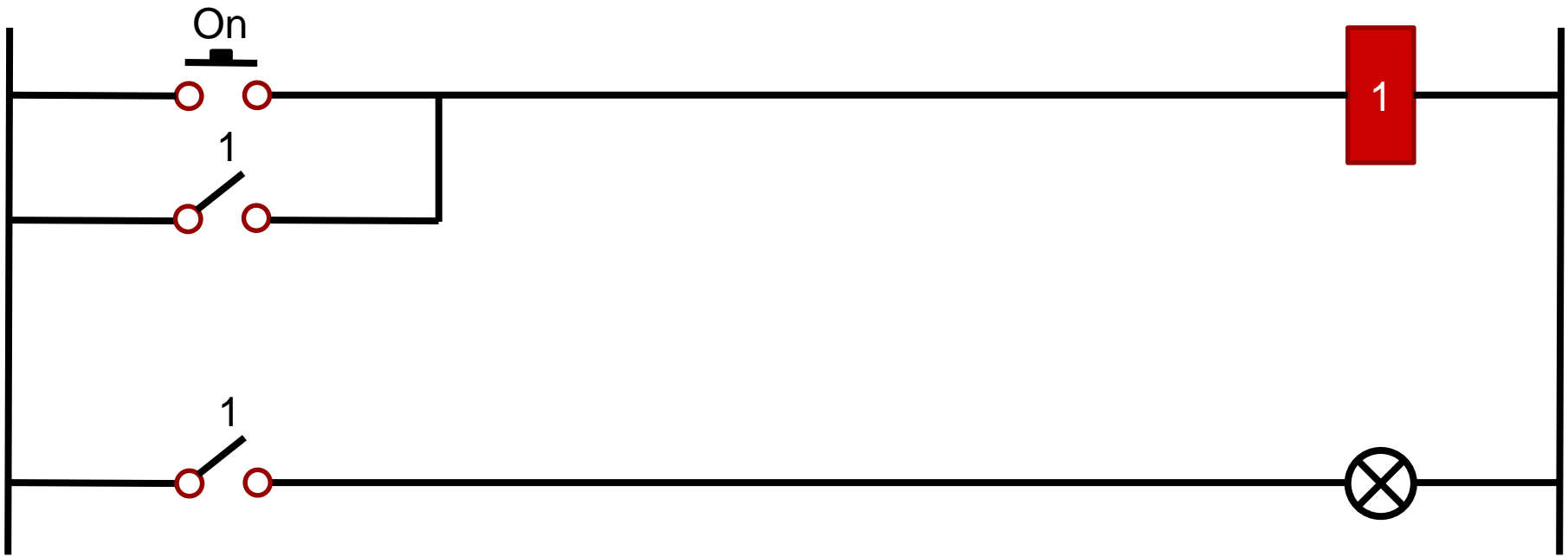

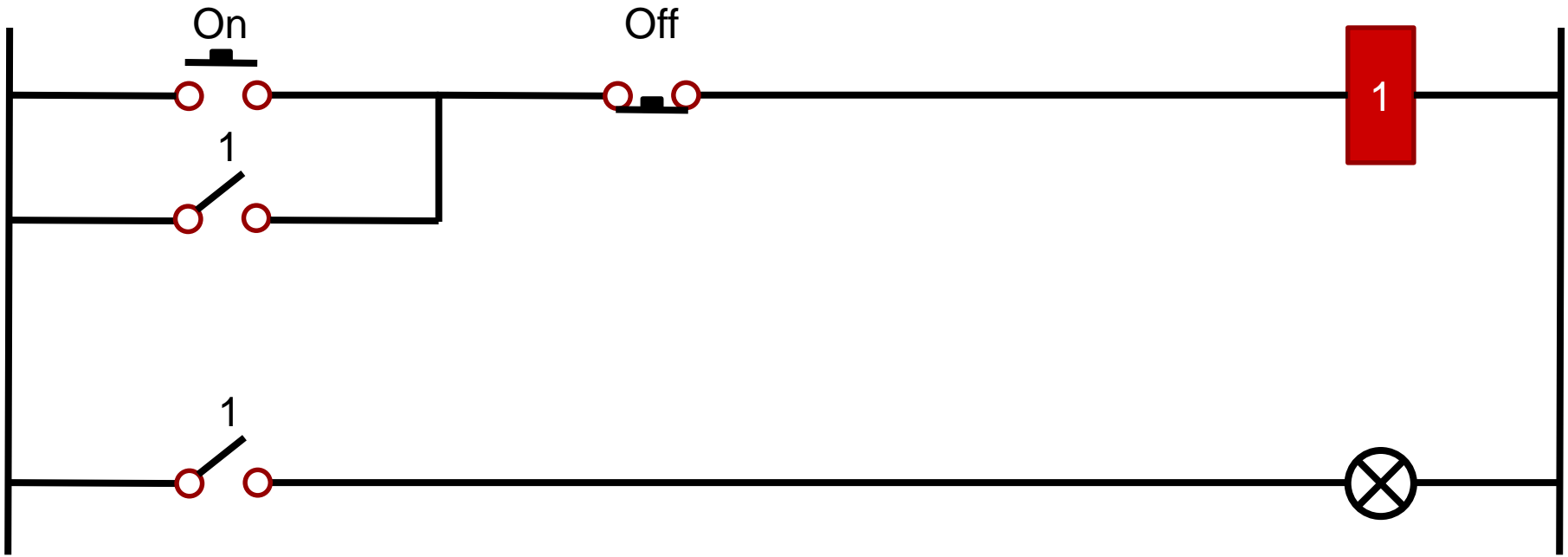

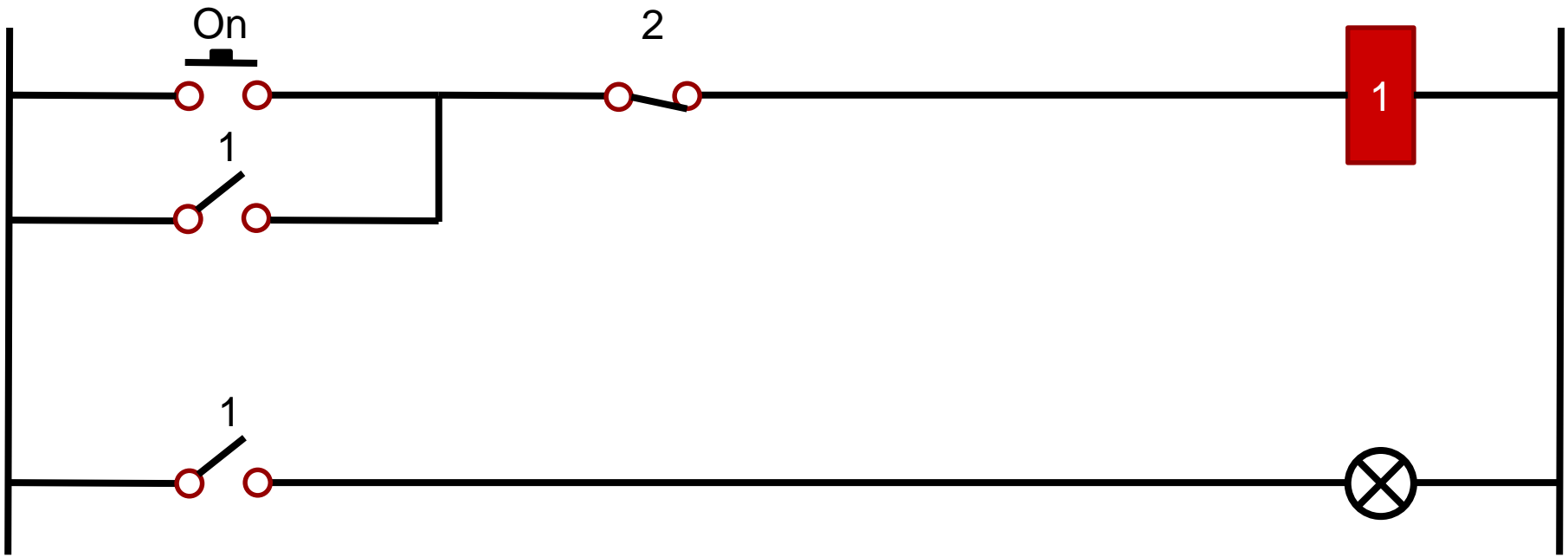

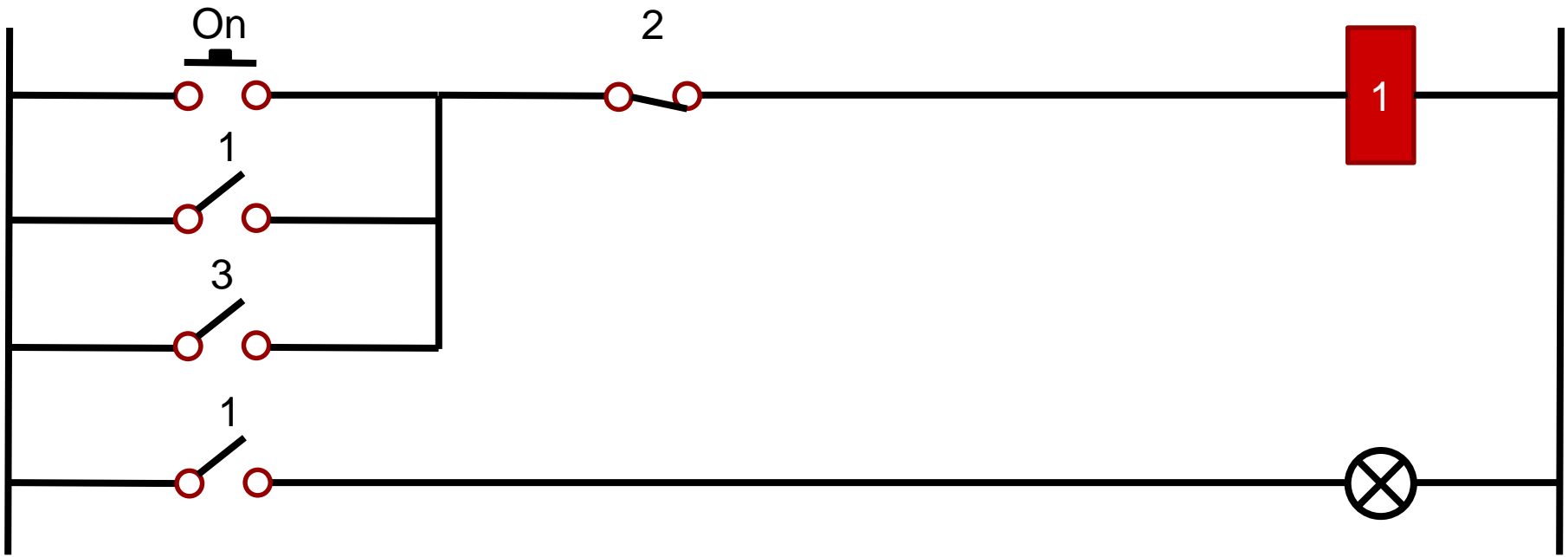

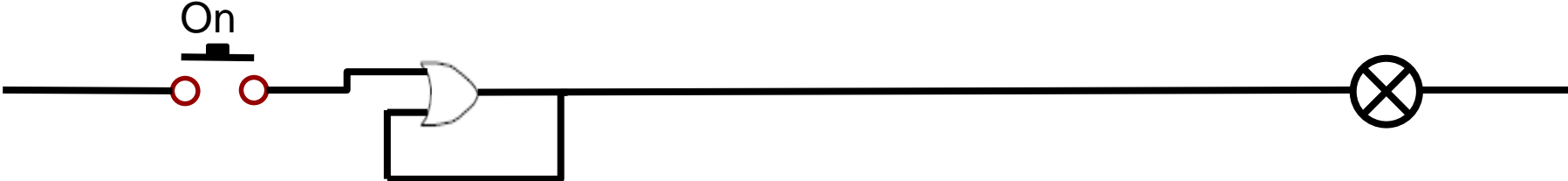

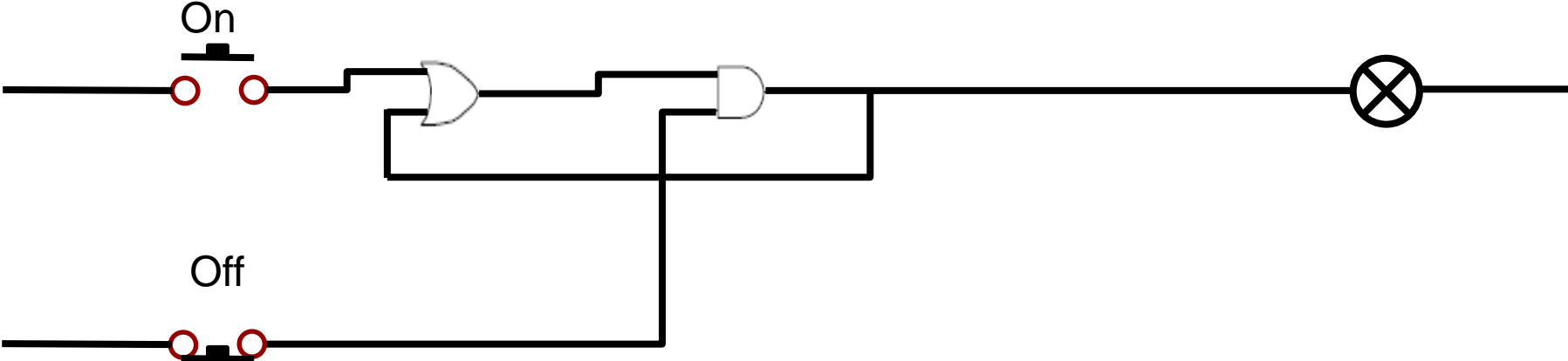

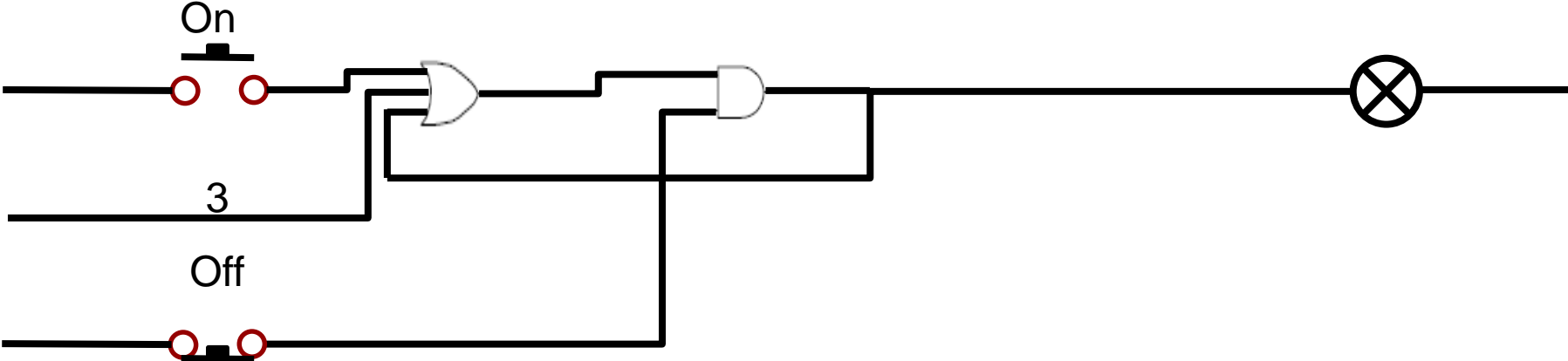

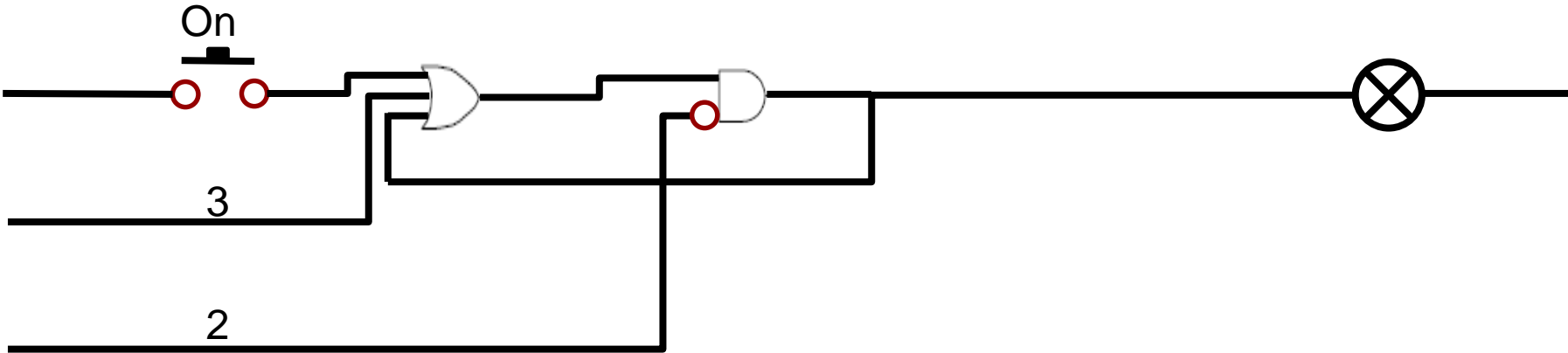

- Not all modelling is graphical
 - The light will be on if the on button is pressed
 - The light will be on if the on button is pressed or the light is on
 - The light will be on if (the on button is pressed or the light is on) and the off button is not pressed
 - The light will be on if (the on button is pressed or the light is on or signal 3 is true) and signal 2 is not true

- Automatic implementation from a specification
 - In the 1980's it became popular to program industrially hardened computers known as Programmable Logic Controllers (PLCs) using ladder logic, as if designing a control system made of relays.
 - This step forward combined modelling skills from the past 30 years with modern technology for a modern solution.
 - This was an easy step for some people changing from relays to computer control,
BUT
it limited some people to continue to think in 30 year old solutions and not to explore new possibilities.

- Decomposition based upon objects, functionality, or sequence

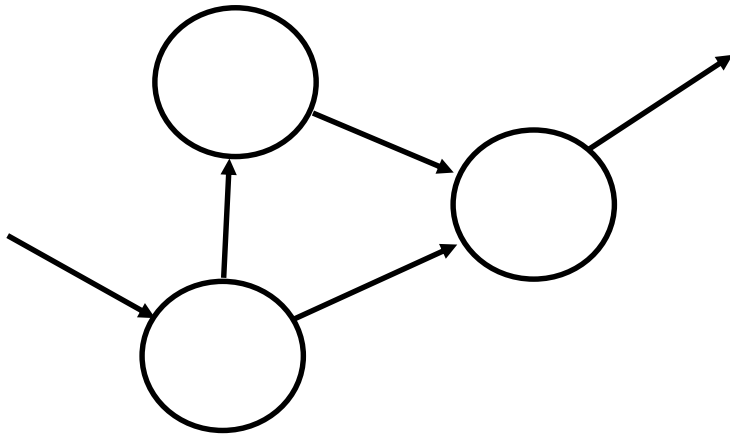
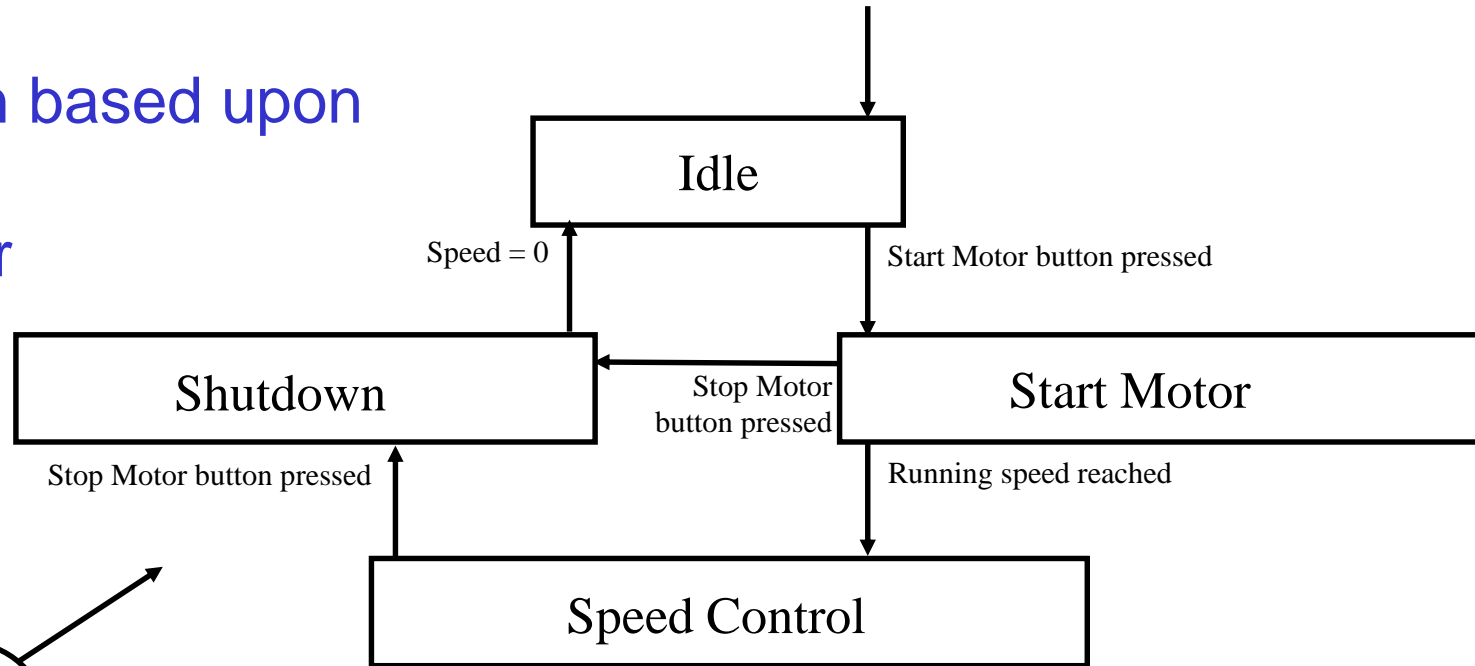

- SysML intended to specify systems

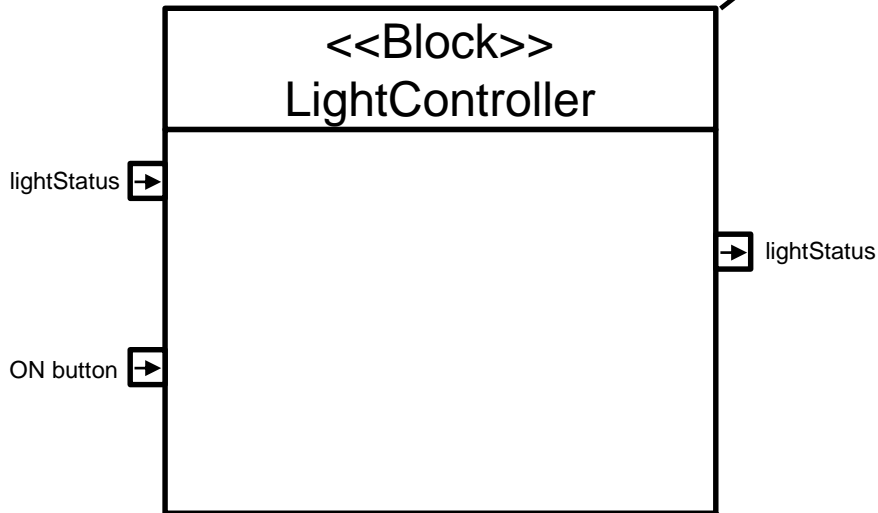

- but....
is mainly used for SW

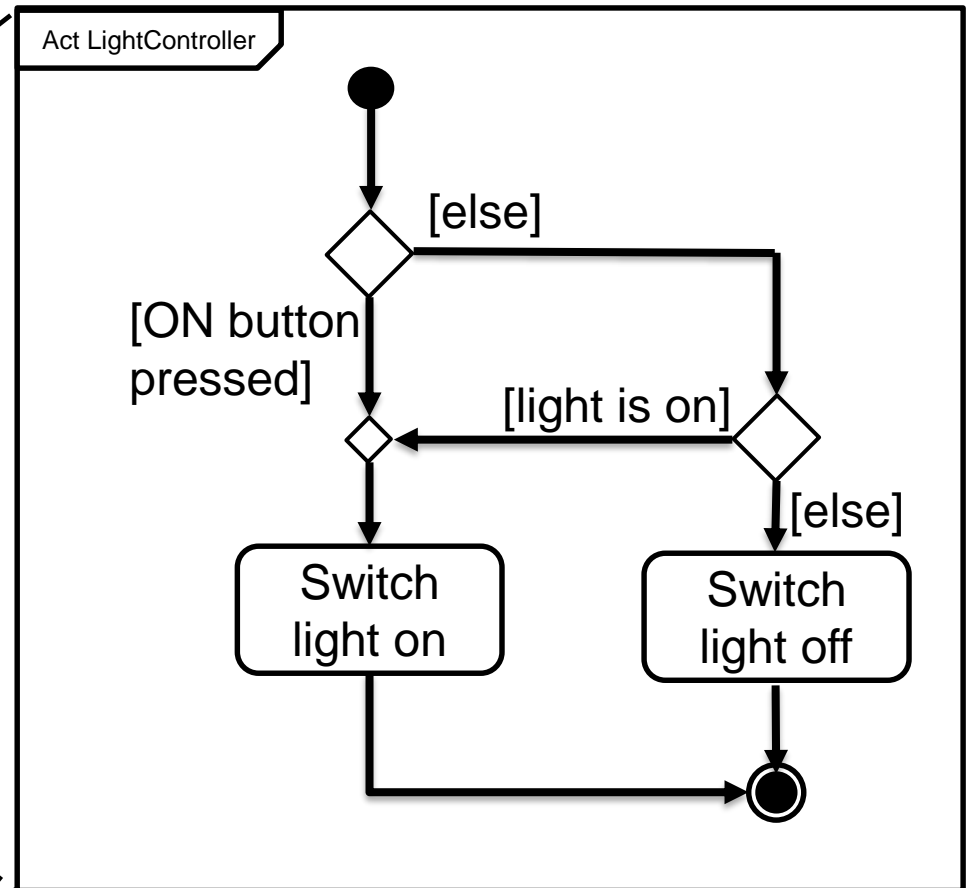

- Using SysML to specify mechanical properties

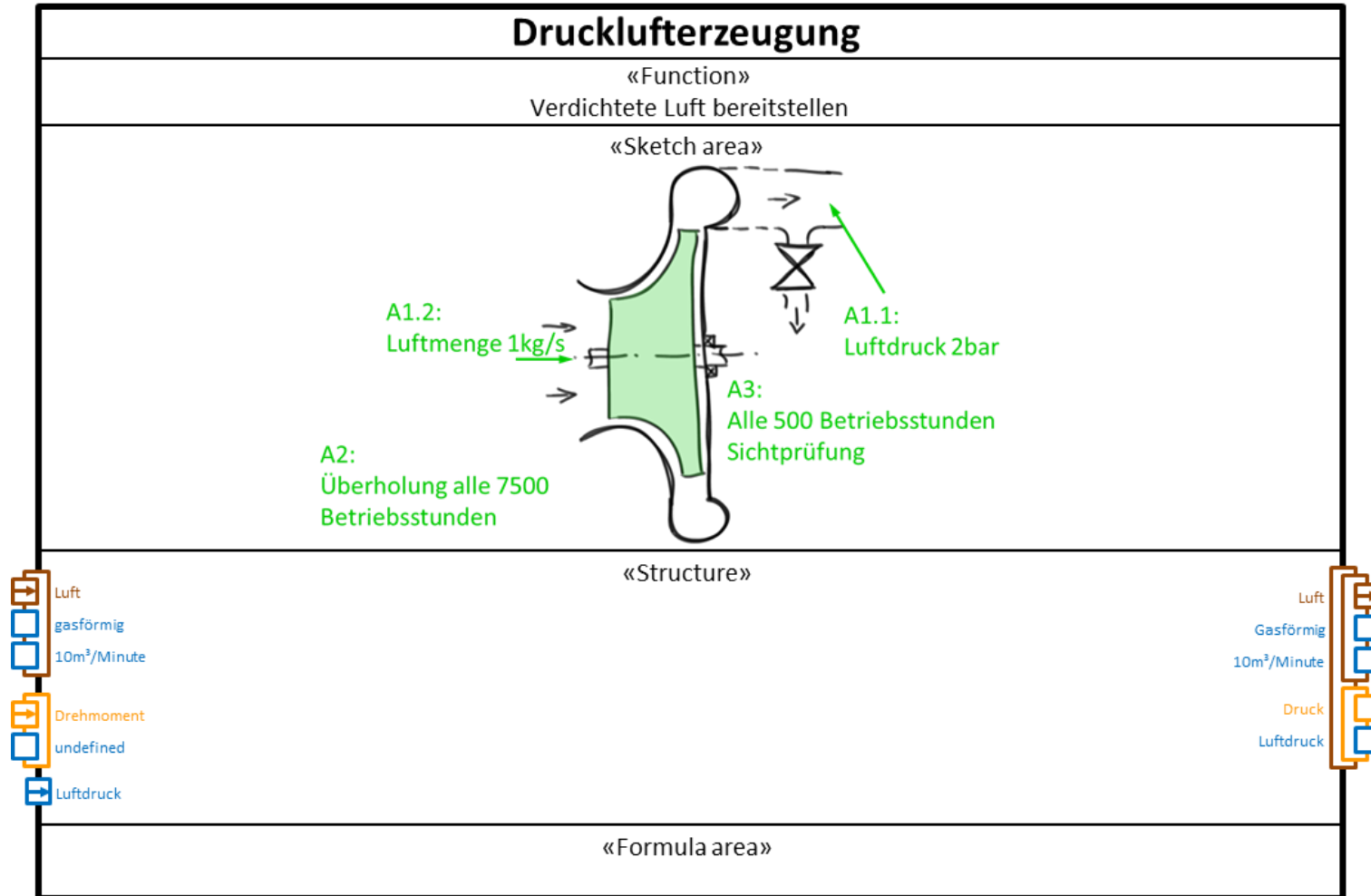

- We see that modelling has been used throughout history, and remains applicable to many domains of systems engineering
- Our experience should not limit us.
Learning from the past allows us to make progress more quickly than re-inventing everything

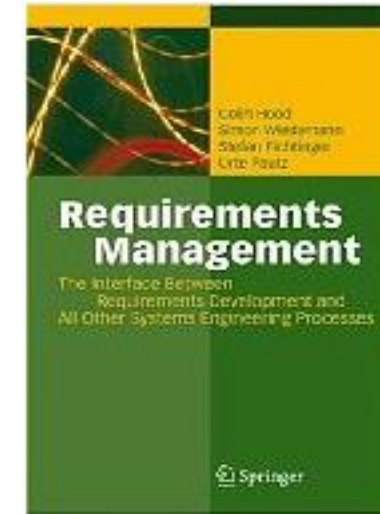
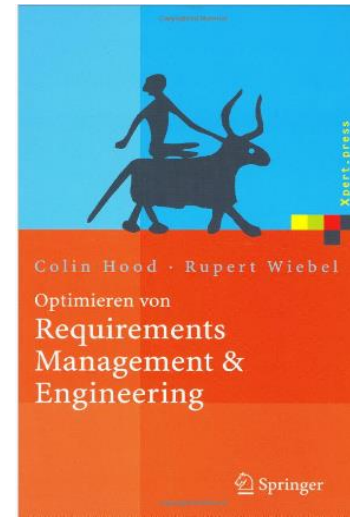
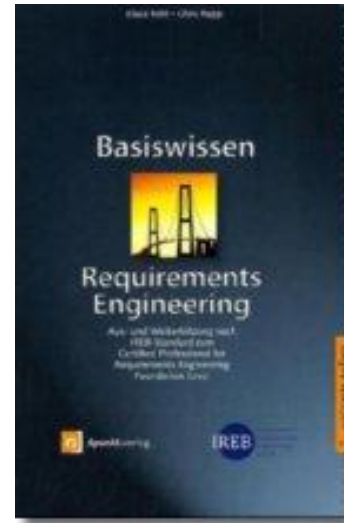
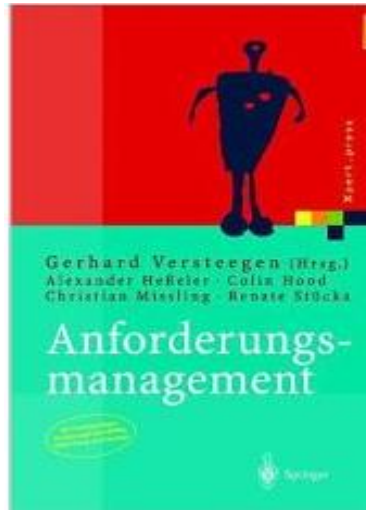

Colin Hood Systems Engineering Limited
Evans Business Centre
Regents Pavilion
4 Summerhouse Road
Northampton NN3 6BJ – UK

info@colinhood-se.com

Founding Board Member of IREB 2006
(International Requirements Engineering Board)



INCOSE member since 1991

www.munich-openspace.de

Save the date: 22 – 24 February 2018 in Munich